

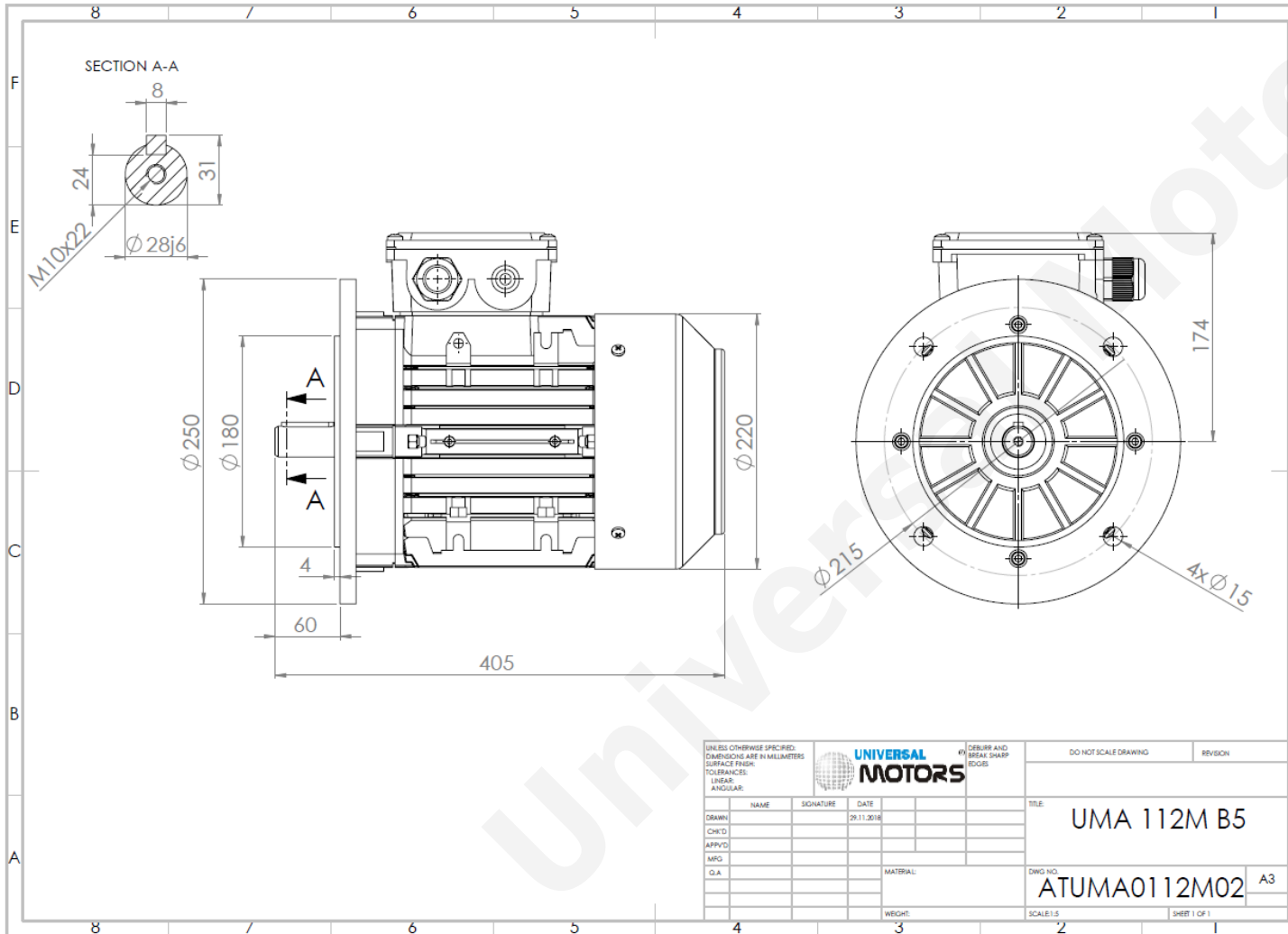

TECHNICAL DATA

Three Phase Electric Motors - Aluminum Frame
 UM3A 112M1-6 IE3
 2.2 kW / 3 Cv
 965 RPM



Motor type:	UM3A 112M1-6 IE3
Output:	2.2 kW / 3 Cv
Speed (min ⁻¹):	965 RPM
Frequency:	50 Hz
Voltage:	400 V
Current:	5.54 A
Power factor (Cos Ø):	0.68
Poles:	6
Insulation class:	F
Temperature rise Class:	B
Efficiency 50%:	83.2 %
Efficiency 75%:	84.5 %
Efficiency 100%:	84.3 %
Torque:	22 N.m
Tstarting/Tnominal:	2.0
Istarting/Inominal:	5.5
Tmaximum/Tnominal:	2.5
Noise:	64 Db(A)
Weight:	27.1 Kg
Brake AC:	AC6
Torque Brake DC:	60 N.m
Bearing DE:	6306 2Z
Bearing NDE:	6206 2Z
Torque Brake AC:	60 N.m
Brake DC:	REB-05-14

Regime - S1

Altitude - 1000m

Environment Temperature - 40°C

CONTACTS:

UNIVERSAL MOTORS Tel: +351 252 299 080
 Rua de São Brás,745 Fax: +351 252 299 089
 4480-782 VILA DO CONDE Mail: geral@universalmotors.pt

* References applied only in the UK